

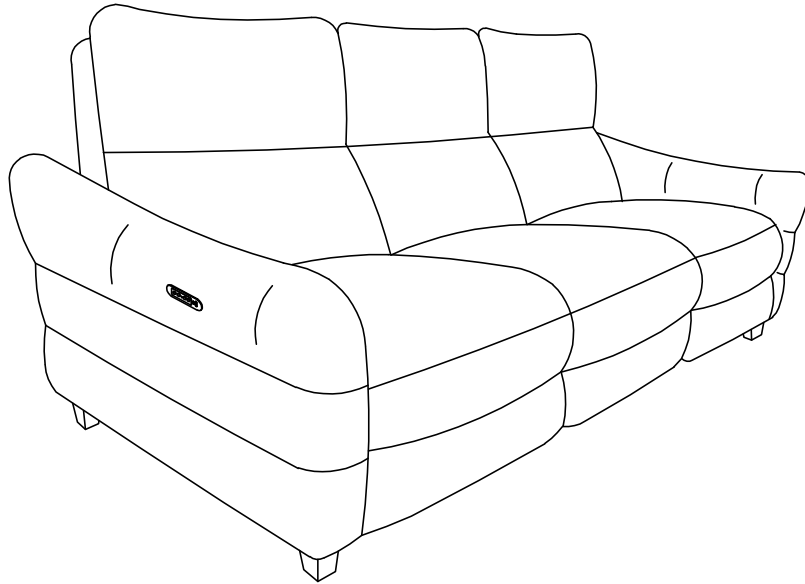

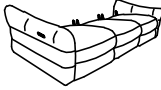



Part# SF-SLOPE87FB XX

25-915

**PART LIST**

NO	Description	Sketch	Quantity
A	Seat Frame		1
B	Back Cushion		2
C	Middle Back Cushion		1
D	Wooden Legs		4
E	Washer		4
F	Wall Plug Transformer		1

## Location of KD parts

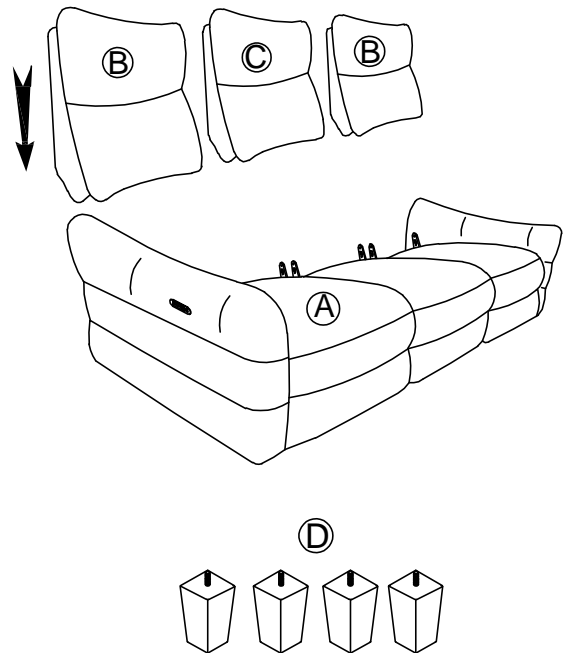

NO TOOLS REQUIRED FOR ASSEMBLY\*

Part# SF-SLOPE87FB XX

25-915

1

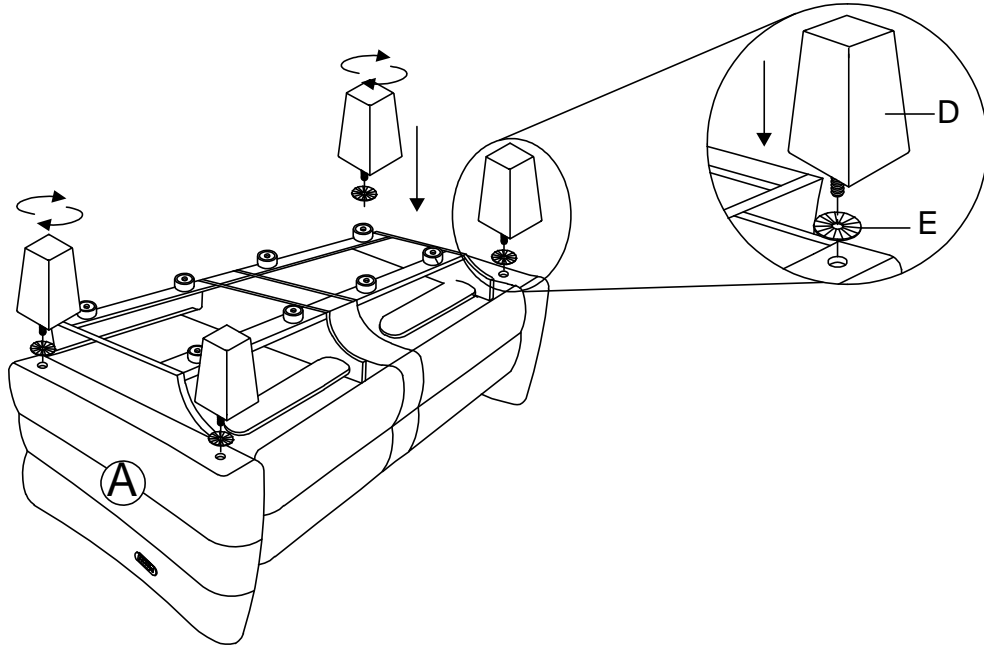

2

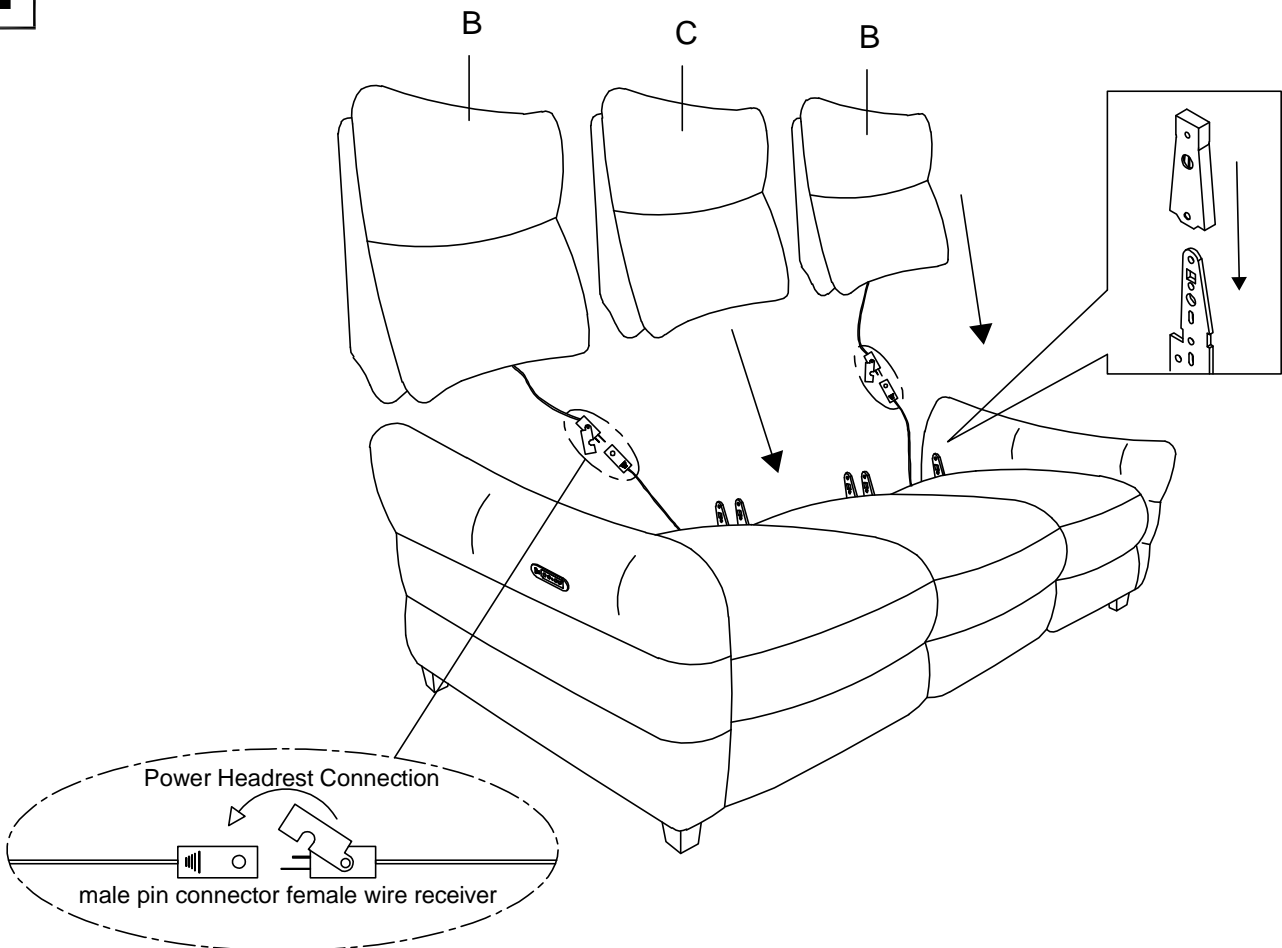

Part# SF-SLOPE87FB XX

25-915

**3**

Connect wire plug firmly into the adaptor located in the lower back corner of the recliner and plug the other end of the transformer cord into a power outlet/wall socket.

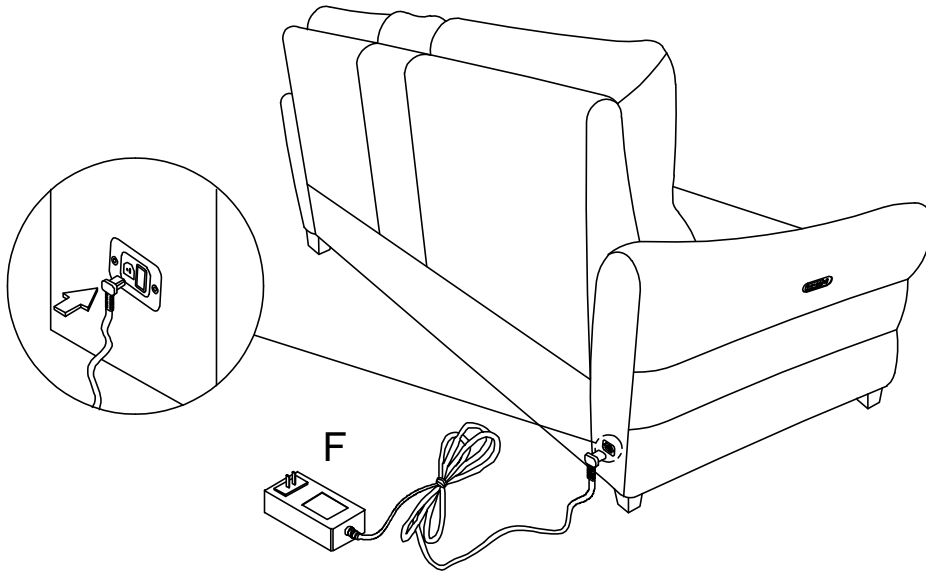

## Power Controls

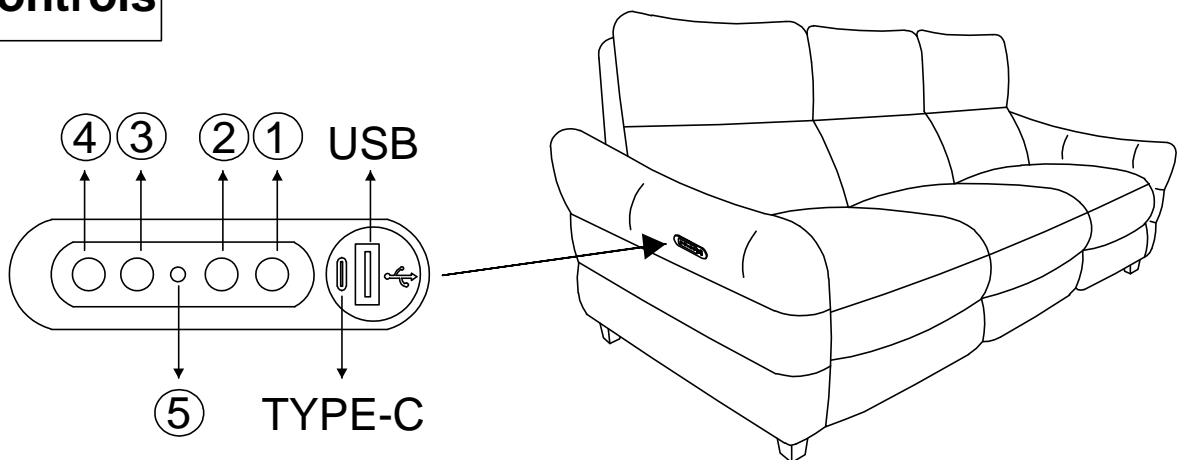

1. Press button ① to recline the chair to desired position.
2. Press button ② to return the chair position and headrest position.
3. Press button ③ to activate the headrest forward.
4. Press button ④ to return headrest to the closed position
5. Press button ⑤ Home button returns both footrest and headrest to the original upright/closed position.

## ⚠ WARNING: SEATING

- Read all instructions carefully and completely before assembly and use. Retain for future reference.
- Keep plastic bags and small parts away from children.
- For residential (non-commercial) use only.
- DO NOT stand on product. Use only for intended seating purpose.
- Max weight limit 250 lbs.
- Periodically check for loose hardware; retighten as necessary.
- DO NOT use product if any component becomes damaged.
- DO NOT use power tools to assemble OR overtighten hardware.

Part# SF-SLOPE87FB XX

25-915

## Care and Cleaning

\*Upholstered furniture is packaged tightly to protect it during transit. This packaging can sometimes cause creases or misshaped cushions when the furniture comes out of the packaging. These issues will correct themselves over time as the fibers of the cushions are exposed to air. However, shaping the cushions with your hands can alleviate the creases and compressed fibers more quickly.



Before shaping



After shaping



\*Dust often and use a vacuum cleaner to remove debris from seams and crevasses.

\*Use a soft damp cloth to gently clean soiled areas and wipe clean. Do not rub.

\*Do not use household cleaners or solvents. Such cleaners may cause damage and/or discoloration.

\*Do regularly use dedicated leather care product onto the leather furniture to prevent built up of body oils.

## WARNINGS

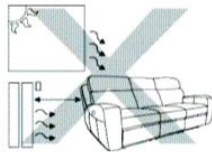
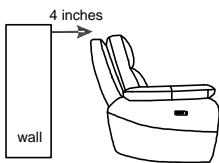

\*Keep unit at least 4 inches from the wall.

\*Keep unit at least 24" from all heat sources.

\*Avoid placing unit in areas where unit can be exposed to direct sunlight other powerful light sources, as fading or discoloration may occur.



\*Do not reach under seat when mechanism is operating or serious injury may occur.

\*Reclining mechanism should only be operated while seated properly.

\*Do not sit on arms or backrest.

\*Do not jump or roughhouse on furniture.

\*If unit must be moved, do not drag. Unit must be lifted in order to be moved.

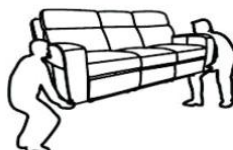

\*Do not continuously operate mechanism for more than one minute or unit may go into protection mode by shutting down to prevent overheating.

\*Unplug unit from power source prior to cleaning mechanism.

\*Do not allow electrical components to come into contact with any liquids.